

View from inside

Cascade Woodwork
Ouray Colorado

www.cascadewoodwork.com

2 panel Lift-Slide

Elevation

Scale - 1/20

Dimensions - inch & millimeter

Production Book - OVERVIEW (Metric/Inch)

Inside View ! Unit will be manufactured in METRIC !!

Unit# 3
Qty. 1

Lift & Slide System with 78mm Sash

Wood: Afr. Mahogany

Finish: Custom Finish

Afr. Mahogany (only for Sash)

Custom Finish (only for Sash)

Glass: (kein)

Glass: Interior flat panel 20mm tk

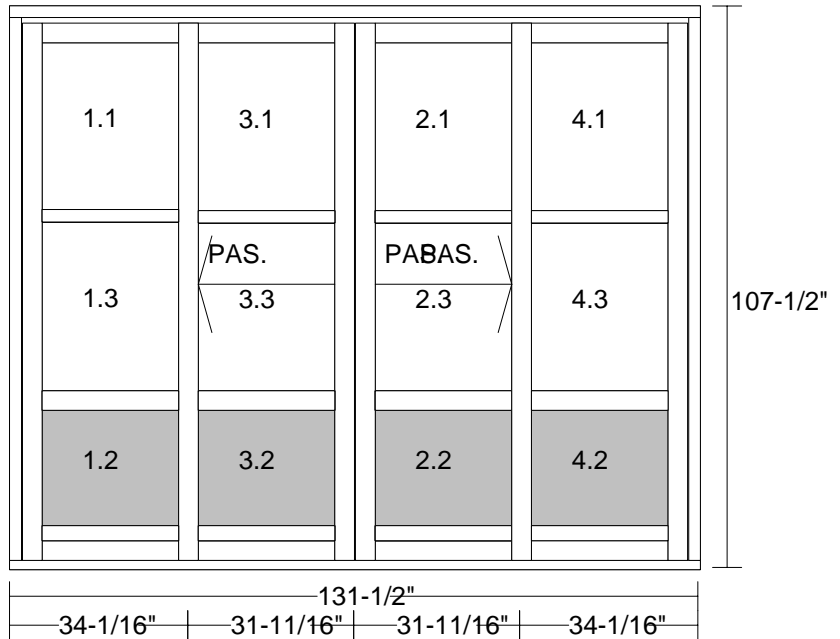

Unit Size: 3340 * 2730
131-1/2" * 107-1/2"

| | | |
|----------------------|------------------------|----------------------------|
| Sash Dim # 1 | 850 * 2601 | 33-1/2" * 102-3/8" |
| Glass Dim # 1 | 690.3 * 837.5mm | 27-3/16" * 33" |
| | 690.3 * 588mm | 27-3/16" * 23-1/8" |
| | 690.3 * 847.5mm | 27-3/16" * 33-3/8" |
| Sash Dim # 2 | 850 * 2601 | 33-1/2" * 102-3/8" |
| Glass Dim # 2 | 690.2 * 842.5mm | 27-3/16" * 33-3/16" |
| | 690.2 * 588mm | 27-3/16" * 23-1/8" |
| Sash Dim # 3 | 850 * 2601 | 33-1/2" * 102-3/8" |
| Glass Dim # 3 | 690.2 * 842.5mm | 27-3/16" * 33-3/16" |
| | 690.2 * 588mm | 27-3/16" * 23-1/8" |
| Sash Dim # 4 | 850 * 2601 | 33-1/2" * 102-3/8" |
| Glass Dim # 4 | 690.3 * 842.5mm | 27-3/16" * 33-3/16" |
| | 690.3 * 588mm | 27-3/16" * 23-1/8" |

Lift-Slide uses the same 3 1/16" thick sash as our window system.

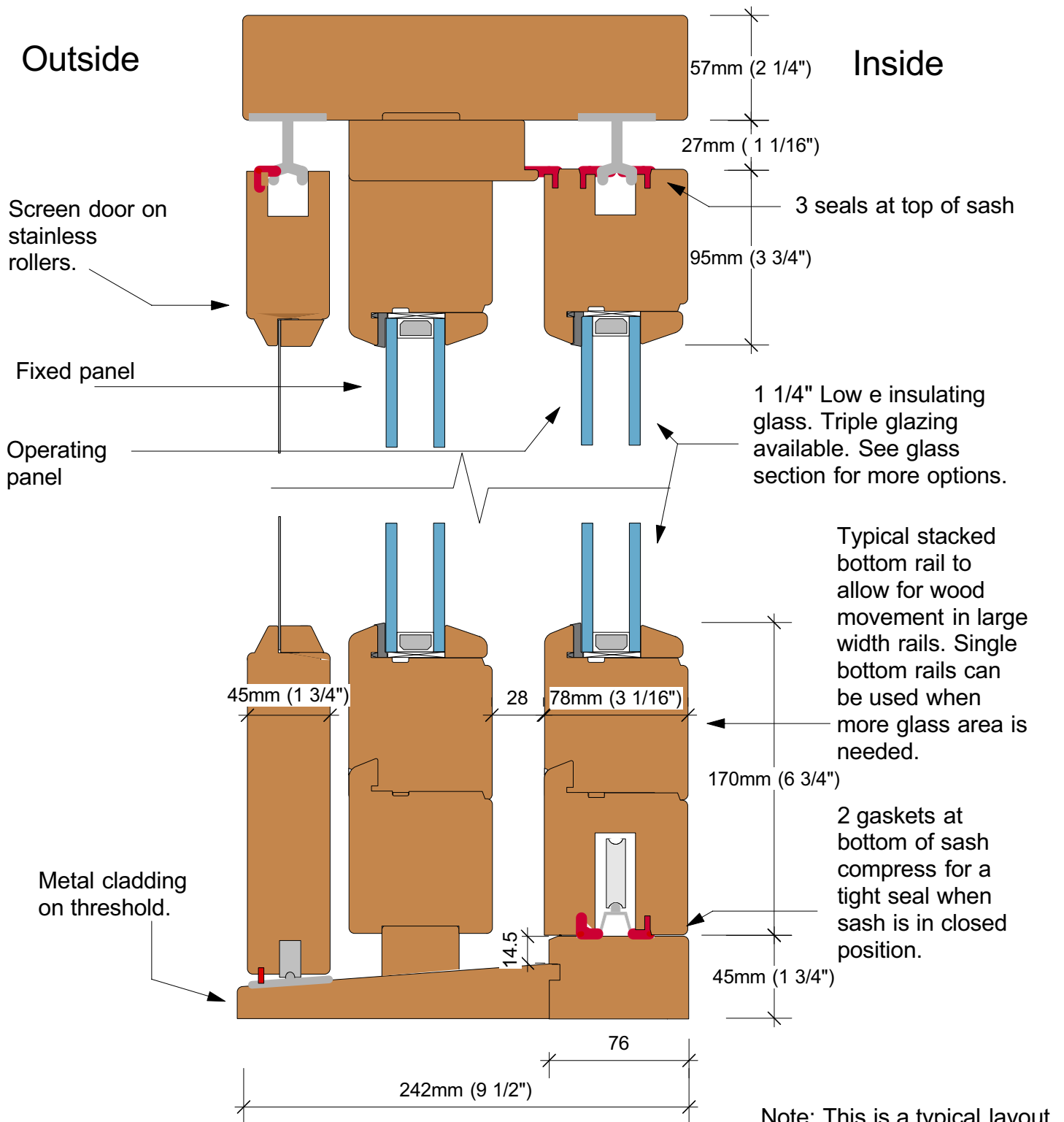

Note: This is a typical layout for a 2 or 4 panel unit with screen doors. Lift-Slide units allow for a lot of design possibilities depending in the application. This is only one of many.

| | |
|--|---|
| <p>Cascade Woodwork Ouray Colorado</p> <p>www.cascadewoodwork.com</p> | <p>Lift-Slide with screen Vertical section Scale - 1/3 Dimensions - inch & millimeter</p> |
|--|---|

Lift-Slide uses the same 3 1/16" thick sash as our window system.

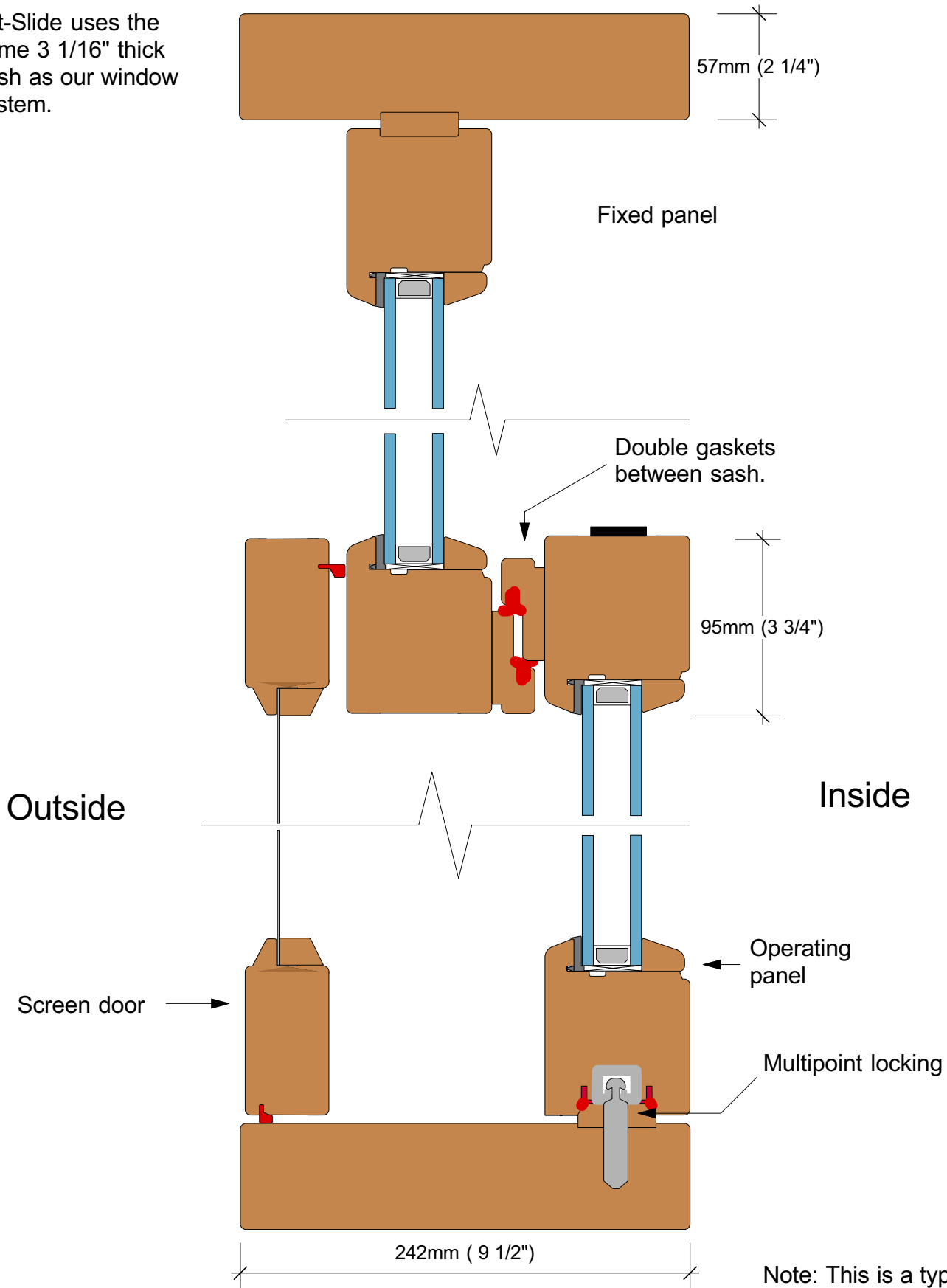

Note: This is a typical layout for a 2 panel unit with screen door. Lift-Slide units allow for a lot of design possibilities depending in the application. This is only one of many.

Cascade Woodwork
Ouray Colorado

www.cascadewoodwork.com

Lift-Slide with screen
Horizontal section
Scale - 1/3
Dimensions - inch & millimeter

Here are just a few layouts possible with Lift-Slide systems

| | |
|--|---------------------------|
| Cascade Woodwork www.cascadewoodwork.com | Lift-Slide layouts NTS |
|--|---------------------------|

X = Moving Panel
 O = Fixed Panel

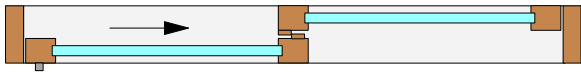

Layout (XO)

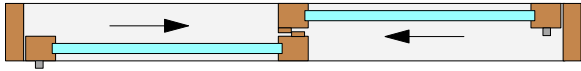

Layout (XX)

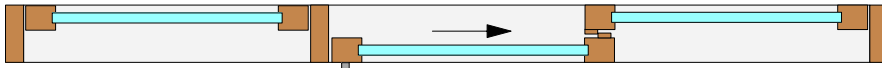

Layout (OXO)

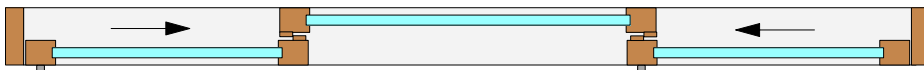

Layout (XOX)

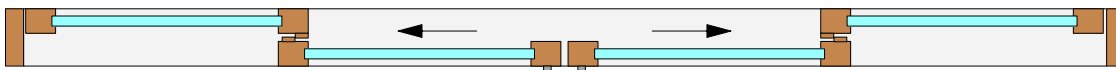

Layout (OXXO)

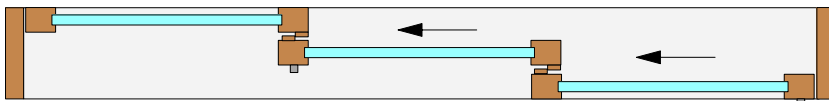

Layout (OXX)

Most Lift-Slide layouts can be pocketed into wall cavities.
 Shown are a couple layouts.

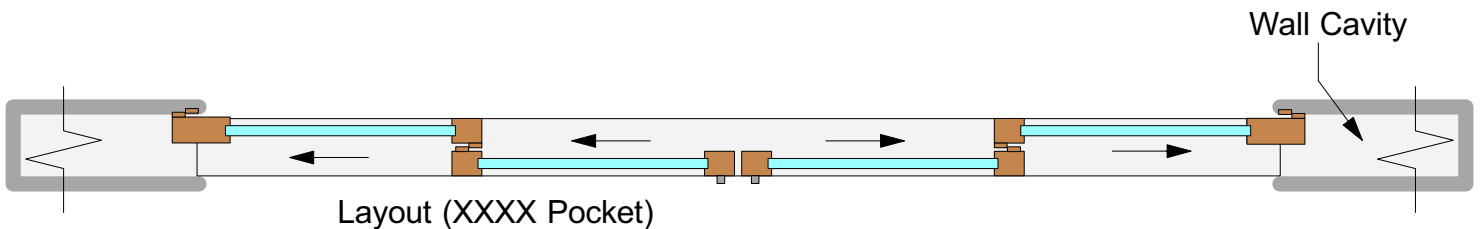

Layout (XXXX Pocket)

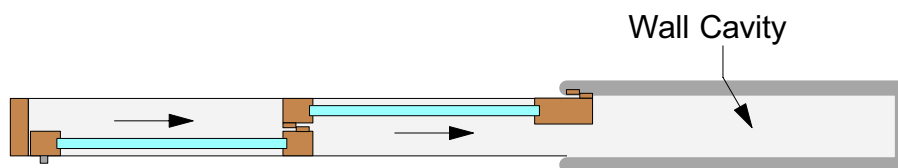

Layout (XX Pocket)

Type A : Typical 78mm European style

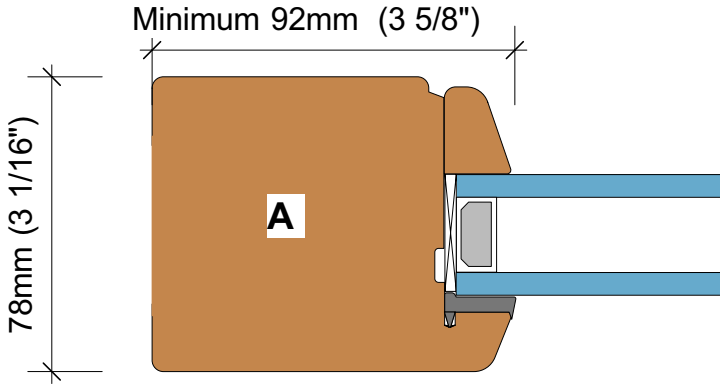

Type B : Arts and Crafts style. Not recommended for weather exposure because flat edges trap moisture.

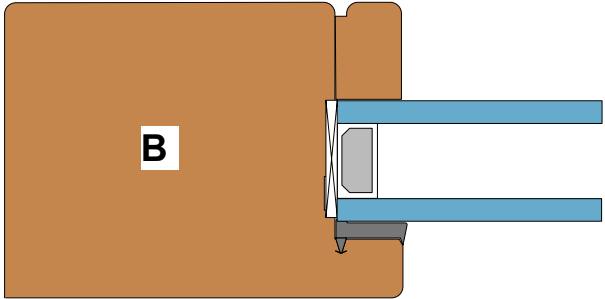

Type C : Arts and Crafts style with good weather protection to the outside.

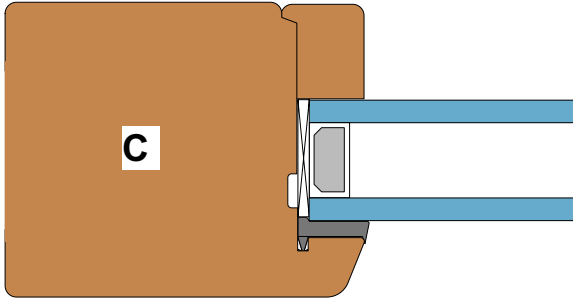

Type D: Traditional or rustic detailing. We can do many variations on this.

